

ROYAL 
BOTANIA

ELMINA[®]
môj životný štýl

ELMINA Bratislava
OC LIGHTPARK, prízemie
Račianska 90, Bratislava
web: www.elmina.sk
mail: elmina@elmina.sk
tel.: +421 910 919 711









Lounge Sets





Mozaix Lounge Styled with cushions in Aubergine Mesh

Mozaix Lounge

Designed by Kris Van Puyvelde, the Mozaix lounge represents the pinnacle of luxury in outdoor furniture, combining refined aesthetics with exceptional comfort. Available in both premium teak and coated aluminum, this modular lounge system allows for endless customization, enabling you to create the perfect outdoor setting. The signature mosaic-like inlays, crafted from teak, lavastone, or even flower pots offer a stunning visual centerpiece that enhances its opulent feel.

Engineered for durability and outdoor resilience, the Mozaix lounge features weather-resistant cushions and materials designed to endure the elements while maintaining their elegance. Whether in teak or aluminum, this piece redefines outdoor sophistication, positioning itself as one of the most luxurious lounges ever created.















Designed by Kris Van Puyvelde, the Mambo Lounge Collection is a masterful blend of natural elegance and thoughtful design. Its warm wooden contours, discreetly supported by a concealed steel frame, speak to the perfect harmony between durability and refined style. The soft curves of the wood seamlessly integrate with plush, inviting cushions, creating a space where comfort is effortlessly elevated.

Whether you opt for the intimate two-seater for quiet moments or choose the versatile modular pieces for larger gatherings, the Mambo adapts gracefully to any occasion. Complete the setting with a Low Lounge table, enhancing both functionality and sophistication.

From tranquil escapes to lively family gatherings, the Mambo Lounge Collection transforms outdoor spaces into luxurious havens, where comfort and style naturally come together, evoking a serene and timeless atmosphere.

Mambo Lounge















Styiletto Lounge

The Styiletto Lounge offers a sophisticated blend of style and functionality. This elegant range features modular pieces designed for adaptability, including teak or ceramic topped tables with tapered legs and plush deeper seating options. This collection allows for easy customization to suit your spatial and stylistic needs. For larger set-ups an impressive 220 or 300 styiletto low lounge table could be used.

The most recent addition of the twin seat, which could be used as a Lounge corner, or a spacious daybed completes the collection. The Styiletto Lounge collection is crafted to deliver unparalleled comfort and timeless elegance, making it a versatile choice for luxury outdoor living.















Organix Lounge

Kris Van Puyvelde, inspired by the beauty of nature's fluidity, designed the Organix Lounge Collection to embody soft, organic shapes with graceful curves and rounded outlines. Whether nestled within a lush garden or serving as a striking contrast to minimalist architecture, Organix integrates effortlessly into any outdoor setting, enhancing its surroundings.

The collection's modular design offers endless possibilities for customization. With four distinct curved backrest cushions and a broad selection of fabric and ceramic top combinations, the Organix Lounge Collection invites you to personalize your outdoor space. This versatility ensures that every arrangement feels as unique and dynamic as the natural environment it complements.















Calypso Lounge

The Calypso Lounge collection strikes the perfect balance between craftsmanship and personal expression. With its inviting design and choice of an upholstered or Kris Kross woven backrest, each piece feels almost bespoke, adapting to your preferences.

The versatility of the Calypso allows for endless customization. Choose from a variety of lengths, fabrics, and finishes to create a lounge that complements your outdoor space with effortless style and comfort. Whether you're seeking a quiet corner to unwind or a space to gather with friends, the Calypso Lounge offers both luxury and flexibility.

Crafted with meticulous attention to detail, the Calypso Lounge invites you to enjoy the outdoors in unparalleled comfort, where every moment feels tailored to you.













Alura Lounge

The Alura Collection embodies versatile design, perfect for crafting personalized outdoor setups. With three robust aluminum base sizes, you can configure pieces into single, double, or triple seaters, and create L- or U-shaped arrangements. Each piece features a sleek, sturdy structure supporting modular back & armrests. Choose from +80 fabric options for cushions, ensuring each arrangement is both comfortable & stylish.

This lounge set integrates seamlessly with the Alura Collection, which includes matching dining chairs, armchairs, low chairs, bar chairs & a sun lounger, offering a cohesive & inviting outdoor living experience.





Alvaro Siza
In/discipline
discipline
EAT DRINK NAP







Ninix Lounge

The Ninix Lounge Collection embodies the essence of refined outdoor living through its minimalist design and enduring construction. The sleek stainless steel frames, paired with optional teak armrests, create a timeless balance of elegance and durability, designed to withstand the elements with ease.

Crafted with Batyline, renowned for its resistance to UV rays, mildew, and stains, the Ninix ensures both lasting comfort and practicality. With customizable finishes, the collection offers the flexibility to tailor each piece to your personal style, making the Ninix Lounge a symbol of understated luxury in any outdoor setting.

















PICASSO & MAYA

Zenhit Lounge

The Zenhit lounge offers a customizable outdoor seating experience with its premium teak pieces. Available in configurations like individual chairs, corner pieces, two-seater, and three-seater units, the collection is designed for versatility. Additionally, modular left and right-handed daybeds can be integrated into the lounge setup or stand alone, allowing you to create your own private oasis. With a wide selection of luxurious fabrics, the Zenhit lounge invites you to personalize your outdoor space for ultimate comfort and style.











Alura Lounge



Calypso Lounge



Mambo Lounge



Mozaix Lounge



Ninix Lounge



Organix Lounge



Styletto Lounge



Zenhit Lounge

Chairs





Carès

The Carès chair embodies the seamless fusion of elegance and comfort. Designed by Kris Van Puyvelde with a thoughtful balance of timeless aesthetics and innovative craftsmanship, this chair invites you to experience the finest in outdoor living. The choice between a natural teak or sleek aluminum frame ensures that the Carès chair effortlessly complements any setting, whether by the pool or on a sunlit terrace.

With its woven backrest, available in Sage Green, Anthracite, or Pebble, this chair not only offers visual texture but also subtle luxury. Each element of the Carès chair is crafted to ensure durability, allowing you to enjoy its beauty and comfort for years to come. The modular design, combined with a new low lounge version, enhances its versatility, adapting to your evolving outdoor space.













Folia

The Folia Collection by Royal Botania stands as a testament to the seamless marriage of artistic inspiration and comfort. Capturing the intricate patterns of leaf veins, the Folia chair is more than a seating option—it is a centerpiece that commands attention. Its meticulous construction mirrors the essence of fine craftsmanship, with each piece standing as a dedication to the pursuit of perfection.

Constructed from slender stainless-steel tubes, the Folia collection boasts frames finished in an array of subtle hues, each chosen to complement the outdoor palette of sophisticated spaces. These pieces do not just fill a space; they create an ambiance of elegance and tranquillity. The introduction of the Folia rocking chair and the low lounge chair invites one to experience comfort in motion or in serene repose, making every moment a luxurious escape.











Ostrea

Inspired by the elegant simplicity of the sea, the Ostrea Chair, named after the Latin word for 'oyster', is a testament to the creative vision of designer Mathias De Ferm. Imagined perhaps over a meal of fresh oysters, these chairs capture the organic contours of its marine namesake through exceptional craftsmanship and innovative design. Each stainless-steel tube is meticulously rolled, bent, and welded, showcasing the high level of artistry involved.

The Ostrea offers two cushion options: a rounded seat that leaves the back exposed or full surface padding that mirrors the oyster's unique shape.









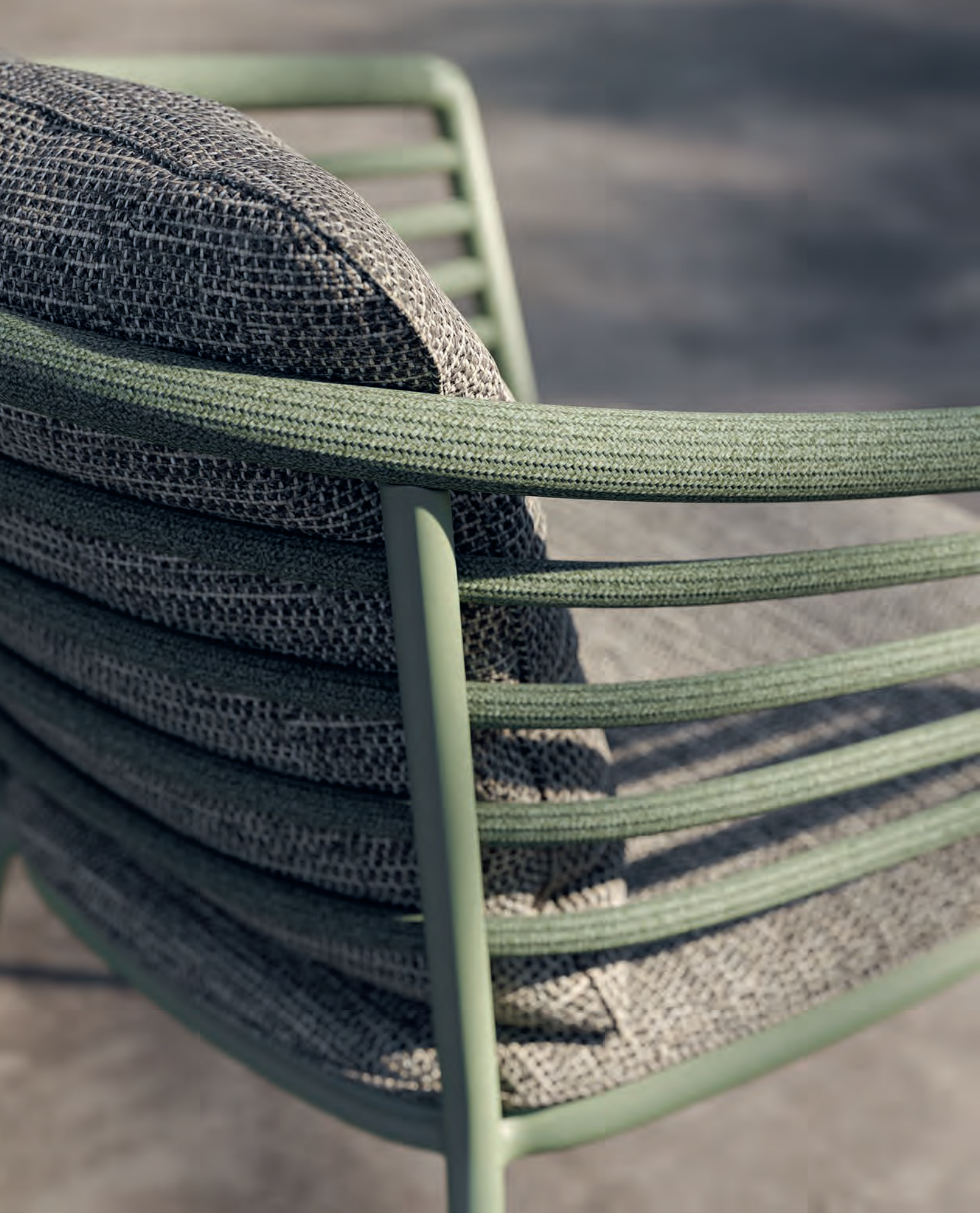

The Archy Chair combines modern design with thoughtful craftsmanship, making it the ideal outdoor companion. Its distinctive sleeves wrap gracefully around the tubular backrest, offering both warmth and durability, while withstanding all natural elements effortlessly.

With a Batyline seat and the option to add a cushion for extra comfort, the Archy invites you to sit back and relax. The frame, available in Pebble, Bronze, and a new Sage hue, harmonizes beautifully with the fiber and strap options, allowing for a combination that reflects your personal style.

Designed to blend seamlessly with any outdoor environment, the Archy Chair is where practicality meets sophistication, offering a balance of comfort and timeless design.



Archy







Exes

A director's chair, elevated by Royal Botania's signature elegance. The Exes Collection, envisioned by Kris Van Puyvelde, showcases bold X-shaped frames crafted from cast aluminum, exuding strength and sophistication. Paired with sleek, tapered teak armrests, the design strikes a perfect balance between modern form and natural warmth.

For added comfort and a touch of personalization, the chairs can feature a teak backrest and seat. The distinctive X-shaped cutouts in the backrest not only enhance the visual appeal but also serve as functional attachment points for plush cushions. This seamless blend of aesthetics and practicality ensures the Exes Collection stands out, offering both refined style and luxurious comfort in any outdoor space.













The Fensi chair boasts a light and airy appearance, thanks to its innovatively designed backrest. This backrest, while resembling a braided pattern, is actually crafted from a thin stainless-steel grid, elegantly wrapped with string to maintain the illusion of natural woven rope without sacrificing ergonomic support. This design ensures both visual appeal and long-term seating comfort.



Fensi



Strappy

In designing the Strappy Collection, Kris Van Puyvelde reimagined outdoor seating with sleek lines and meticulous attention to detail. The collection's signature straps, elegantly wrapped around the frame, create a distinctive aesthetic while ensuring resilience and comfort, no matter the weather.

Crafted from premium materials, the Strappy Collection balances lightweight elegance with lasting durability. The frame, available in a range of refined finishes, offers the flexibility to customize each piece to perfectly complement your outdoor space. Whether grouped around a dining table or used as standalone seating, the Strappy Collection integrates seamlessly into any setting.

With its contemporary silhouette and understated luxury, the Strappy Collection invites you to experience a perfect blend of style and comfort, redefining outdoor living in its purest form.















Calypso

The Calypso Collection features a selection of outdoor seating options, each piece showcases a durable teak base paired with a stainless-steel backrest with padded upholstery. These removable covers are designed for easy maintenance, simplifying cleaning and seasonal storage.

Available in a wide range of textiles, the collection offers extensive colour customization options to reflect any mood or style. Additionally, the collection features a “Kris Kross” weaving pattern, crafted from synthetic outdoor fibre, providing a choice between woven and textile backrests.









Jive

Discover the versatility of the Jive Collection, where chairs seamlessly blend into both modern and classic settings. Available in three unique material combinations, the Jive chair can be customized with either a teak or aluminum backrest, and the seat is offered in weaving, aluminum, or Batyline options. For added comfort, you can choose to add cushions, or opt for the sleek, cushion-free Batyline version, ensuring a perfect fit for your style and needs. Whether you're looking for functionality, elegance, or a mix of both, the Jive Collection adapts effortlessly to any space.









Designed by Kris Van Puyvelde, the Mambo Chair and Mambo Low Chair offer a perfect balance of comfort and style. With their rounded wooden frames and plush cushions, they bring a welcoming elegance to any outdoor space.

The Mambo Chair is perfect for dining, while the Mambo Low Chair offers a relaxed lounge experience. Both are customizable with luxurious fabrics, ensuring they complement your personal style.

Timeless in design and rich in comfort, the Mambo chairs elevate any outdoor setting with understated luxury.



Mambo







O-zon

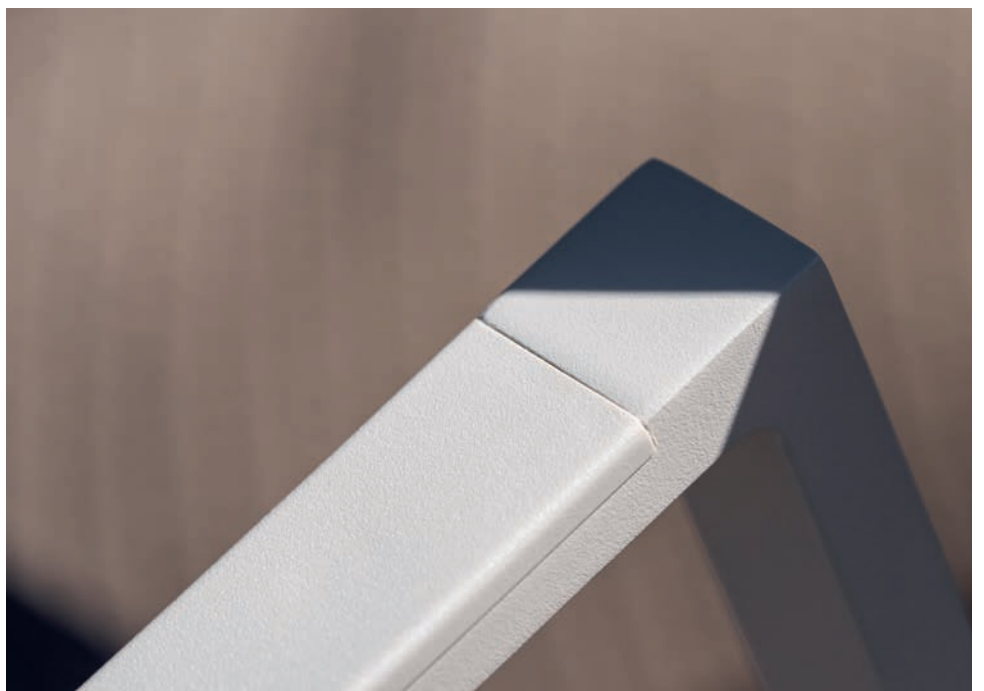



The Styletto collection from Royal Botania redefines minimalist elegance, blending streamlined design with advanced technical features to enrich the outdoor living experience. Engineered for versatility and durability, the Styletto chair complements any outdoor setting seamlessly.

The robust aluminium dining chair features a modular seating system, enhanced by quick-drying cushions and a snap-on back cushion for superior comfort and easy storage.



Styletto







Alura

The Alura Collection offers a blend of elegance and practicality, perfect for any outdoor space. This collection features a dining chair, armchair, low chair, bar chair, and sun lounger, all designed to be stackable for easy storage. The integrated armrests are available in matching finishes or optional teak for a natural touch.





Zenhit

Crafted from the finest teak, the Zenhit Dining Chair and Low Chair embody both durability and timeless elegance. Their modest yet sophisticated design complements any outdoor setting, offering a refined balance of comfort and style. With clean lines and exceptional craftsmanship, these chairs provide a seamless addition to your outdoor living space, making them ideal for both dining and lounging. The Zenhit chairs ensure that every moment outdoors is an experience of luxury and understated beauty.









For over two decades, the Ninix Chair has been an iconic staple in the Royal Botania collection, consistently admired by discerning customers around the world. Its enduring appeal stems from the seamless fusion of minimalist design and unmatched functionality.

With its sleek lines and high-quality materials, the Ninix Chair continues to set the standard for modern outdoor luxury. Thoughtful details, such as the precisely inlaid armrests, integrated Batyline slings, and concealed rollers, reflect the innovative craftsmanship that defines Royal Botania.

A true symbol of timeless design, the Ninix Chair offers a perfect balance of refined aesthetics and lasting functionality, making it a trusted companion in any outdoor space, season after season.



Ninix



Samba

The Samba chair brings a vibrant blend of style and comfort to any outdoor setting. Its sleek, curved lines and carefully crafted structure make it both visually striking and inviting. Built with durable materials for long-lasting use, the Samba chair's ergonomic design offers exceptional comfort for extended outdoor dining. Available in 3 different colors,, this chair seamlessly adapts to various outdoor aesthetics, offering a perfect balance of contemporary design and timeless appeal. With the Samba chair, you can enjoy both luxury and comfort in your outdoor space.





The name XQI refers to the exquisite comfort these pieces offers. For so many years, XQI has been part of the Royal Botania collection, and still they don't look dated. Could it be they are timeless?

There are three colours options of Batyline sling, to complement the frames made of the finest teakwood. And you can be sure of one thing...whichever colour you choose, they will look great on your terrace for many many years to come...



Xqi



Qt

Some say the QT range gets its name because the items look 'cute'. Others have suggested it is because the chairs, loungers and footrests are ideal for spending 'Quality Time'. Both are accurate! Each QT piece is an exercise in minimalism.

The stainless steel profiles (available in a brushed, electropolished, or powder coated finish), look notably slim. Obviously they have been designed to provide the level of strength and stability that Royal Botania stands for.

What's more, all the QT chairs and loungers are stackable. No wonder so many of our customers are 'Quite Taken' with them.



New England





Carès Dining



Archy Dining



Calypso Dining



Calypso Bar



Calypso Low



Folia Dining



Folia Low



Folia Rocking



Exes Dining



Exes Low



Alura Dining



Alura Bar



Alura Low



Jive Dining



Jive Low



Mambo Dining



Mambo Low



Ostrea Dining



Ostrea Low Dining



Ostrea Bar



Fensi Dining



O-zon Dining



O-zon Bar



Samba Dining



Samba Low



Styletto Dining



Styletto Dining



Styletto Bar



XQI Dining



XQI Bar



Strappy Dining



Strappy Low



Strappy Rocking



Zenhit Low



Zenhit Dining



Ninix Dining



Ninix Low



Ninix Bar



QT Dining



New England

Tables





Stiletto

As its name suggests, the Stiletto Table stands with the same poise and elegance as a fine stiletto heel. Its slender, tapered legs bring a sense of grace and lightness to any space, while offering the strength and stability needed for outdoor living. Available in a range of heights and finishes, the Stiletto Table seamlessly adapts to both intimate settings and larger gatherings.

Crafted with meticulous attention to detail, this table blends minimalist design with luxurious materials, ensuring both functionality and style. Whether as a striking dining table or a low lounge piece, the Stiletto Table effortlessly complements your outdoor environment, adding a touch of refined elegance that is both timeless and modern.

With its sleek silhouette and enduring charm, the Stiletto Table is as much a statement of style as it is a piece of functional design.







Surf Shacks
RICARDO BOFILL
STUDIO DE ARCHITECTURE





Designed by Kris Van Puyvelde, the Regaliz Table stands as the epitome of outdoor luxury. Its striking oval-shaped teak bases support a glass top, available in unique finishes such as dark green, dark brown, and pebble—each creating a distinct visual impact. The glass, crafted with a special melting technique, adds an exclusive texture, setting the Regaliz apart in the outdoor market.

Available in sizes ranging from 310 up to 490 cm, the table's modular design features trapezium-shaped sections, offering both grandeur and flexibility. Whether hosting an intimate gathering or a large outdoor event, the Regaliz Table delivers unmatched elegance and functionality, becoming the centerpiece of any sophisticated outdoor space.



Regaliz







The Conix Table Collection is a masterclass in architectural finesse, featuring striking conical bases crafted from fibre-reinforced Ductal® concrete. These robust foundations are presented in two distinct hues: a warm desert beige that imparts a subtle elegance, and a cool industrial grey that offers a sleek, modern appeal. The collection includes an array of tabletop shapes, including the intriguing squircle, each polished to enhance tactile and visual pleasure.

The refined design continues with the variety of available heights, ensuring that the Conix tables are as versatile as they are visually compelling, perfect for transforming any outdoor or indoor space into a sophisticated dining area. The combination of durable materials and thoughtful design makes the Conix collection an exemplary choice for enduring style and functionality



Conix











As part of the renowned Conix collection, this side table showcases the innovative design and durability for which Royal Botania is celebrated, making it a refined addition to any outdoor setting. The concrete base is available in two hues, grey and beige, while the top comes in a choice of lava stone, ceramic, concrete or teak, offering versatility and style for various design preferences.





Furniz

The Furniz table designed by Kris Van Puyvelde, redefines outdoor living with its elegant design and functional innovation. Featuring a base with an integrated heating element, this table is designed to extend the warmth of summer well into cooler months. Ideal for alfresco dining or outdoor gatherings, the Furniz table combines modern sophistication with the comfort of a heated base, allowing you to enjoy the outdoors in style, no matter the season.









Butler

The Butler Collection by Royal Botania offers versatility with an elegant frame crafted from coated stainless steel, available in nine different heights to suit any setting, from lounge areas to dining spaces. The collection provides an array of tabletop options, including ceramic, enamelled lava stone, and teak, allowing you to personalize each piece to complement your outdoor style.

A highlight of the collection, the Butler dining table, features a sleek central base that maximizes legroom for a truly comfortable dining experience. Blending flexibility with modern design, the Butler Collection brings effortless style and function to any outdoor space, adapting with ease to your lifestyle.









The very first side table Royal Botania launched nearly 30 years ago was called Butler. Today, we've recycled the name and adapted the solid teak with a coated stainless steel frame available in four colours and two heights.

There is a very wide array of materials for the table tops. In addition to solid teak, there are also nine different ceramics, and six colours of enamelled lava stones.

Providing extensive customization options for specific design and functional requirements, these side tables are a nice match to just about any low seating set or lounge combination.





Zidiz

This collection stands out for its exquisite craftsmanship, particularly showcased in its large wooden slats crafted from the highest quality wood available. These meticulously chosen materials ensure that the Zidiz collection boasts some of the most beautiful wood table surfaces in the world. A prime example is the extendable ZIDIZ 320 table, offering versatility with its adjustable length ranging from 220 to 330 cm, catering to varying numbers of guests with ease.









Exes

Complementing the Exes chairs, the collection includes tables featuring the same X-shaped legs in the form of a tripod for round tabletops and four-legged frames for a variety of oval-shaped tabletops. Available in a selection of ceramic finishes, the Exes Collection seamlessly integrates into contemporary settings, enhancing both indoor and outdoor environments with its industrial yet elegant design.





U-nite

The U-Nite collection seamlessly blends architectural design with warm aesthetics, offering a variety of teak or powder-coated aluminum frames paired with floating ceramic or teak tabletops. The ceramic tops fit perfectly within the frame thanks to their angled design, creating a sleek and polished look. Available in multiple sizes and shapes, this collection's clean lines and refined style make it an exceptional choice for contemporary outdoor dining areas.









The Taboela Collection boasts one of the most expansive selections of tables available, ensuring a perfect match for any terrace, large or small. Ranging from 80 to 340 cm in length, Taboela tables come with frames in either stainless steel or coated aluminium, tailored to suit diverse aesthetic and functional needs. Choose from a variety of exquisite top materials including glass, ceramic, or teak to complement your outdoor decor. Notably, the collection features two sizes of clever extension tables, making Taboela the ideal choice for those who value flexibility and style. With Taboela, experience the luxury of finding the perfect table for every outdoor setting.

Taboela



Inspired by the classic English gate-leg table, designer Mathias De Ferm reimagines the concept with the Traverse table, blending convenience with modern design. Its flexible structure allows you to use it partially open for smaller gatherings or fully extended for larger groups. With an easy-to-use sliding support system and a slim profile when folded, it's perfect for adaptable, stylish outdoor spaces.



Traverse







Xqi

The XQI tables offer a simple yet elegant design, making them a versatile addition to any outdoor space. Crafted from high-quality teak, these tables are built to withstand the elements while maintaining their natural beauty. Available in a range of sizes, the XQI tables are perfect for both small gatherings and larger outdoor dining setups, combining durability with timeless style.





The Ninix tables feature a sleek, minimalist design with a frame crafted from steel or coated steel, offering both strength and style. The table tops are available in either teak or ceramic, allowing you to choose the look that suits your space. For added versatility, the Ninix range includes an extendable version, perfect for accommodating larger gatherings while maintaining its modern, streamlined aesthetic.





Conix Ellipse Dining



Conix Round Dining



Conix Ellipse Low Dining



Conix Sidetable



Styletto Oval Dining



Styletto Round Dining



Styletto Oval Low Dining



Styletto Sidetable



Regaliz Dining



Regaliz Low Dining



Furniz Dining



Furniz Low Dining



U-nite Dining



U-nite Dining



U-nite Round



U-nite Sidetable



Exes Oval Dining



Exes Round Dining



Exes Ellipse Dining



Taboela Dining



Butler Dining



Butler Low Dining



Butler Sidetable



Traverse Square Dining



Traverse Round Dining



Zidiz Oval Dining



Zidiz Ellipse Dining



Zidiz Oval Dining



XQI Dining



XQI Bar



Ninix Dining



Ninix Dining

Sunloungers





The Styletto Sunlounger, designed by Kris Van Puyvelde, exemplifies minimalist sophistication. Its sleek, streamlined form seamlessly merges style and comfort, offering a truly luxurious outdoor lounging experience. With an adjustable backrest supported by gas springs for effortless precision, and large castors for easy mobility, the Styletto is as practical as it is elegant.

Crafted from durable, high-quality materials, the Styletto Sunlounger combines strength with refined aesthetics, standing out as a sophisticated choice for any outdoor space—without the need to say so.



Styletto











Alura

The Alura sunlounger stands out with its patented positioning mechanism. A hidden piston in one of the rear legs allows seamless adjustments, lifting the knees, lowering the footrest, and raising the backrest simultaneously for ultimate comfort.













Calypso

The Calypso sunloungers offer a truly personalized lounging experience, with upholstered backrests available in a wide array of options and fabrics to perfectly match your style and space, making the lounge feel almost bespoke. The backrests feature removable covers that zip on and off with ease for simple seasonal cleaning and storage. For a more natural aesthetic, the Kris Kross weave blends three tones of weather-resistant synthetic fibers, adding both texture and durability to your outdoor setting. With its customizable design and premium materials, the Calypso sunlounger seamlessly blends style and comfort in any outdoor environment.





The Ninix sunlounger is the iconic piece that brought Royal Botania to international acclaim. Renowned for its sleek design and unparalleled comfort, this sunlounger can be found adorning gardens and outdoor spaces in nearly every corner of the world. Its minimalist aesthetic, combined with top-quality materials, creates a perfect balance of style and durability. As the defining piece of the Ninix collection, it continues to set the standard for outdoor luxury, making it a timeless favorite for both private residences and high-end hospitality venues globally.



Ninix







Zenhit

Crafted from the highest quality teak for durability and timeless elegance, the Zenhit sunlounger enhances the collection by offering spacious lounging with wheels for easy mobility - allowing you to effortlessly adjust your relaxation spot with the moving sun. This collection, matching the Zenhit Lounge, promises a comprehensive approach to luxurious outdoor living, ensuring every moment outside is as comfortable as it is stylish.





Surf Shacks





O-zon

The O-zon Sunlounger, designed by Kris Van Puyvelde, is a perfect blend of sleek design and lasting comfort. Its circular form and clean lines create a striking visual presence, while the ergonomically designed frame offers exceptional comfort for outdoor lounging. With adjustable backrest positions and a robust stainless steel frame, the O-zon Sunlounger delivers both flexibility and durability. Its minimalist design, combined with high-performance materials, makes it an ideal addition to any sophisticated outdoor setting, offering a luxurious experience without the need for overstatement.





Qt

The QT range is renowned for its minimalist design and practicality, featuring loungers crafted from slim yet sturdy stainless steel. Ideal for quality time outdoors, these pieces combine lightweight construction with exceptional stability and comfort.









Beacher

The Beacher has been thriving in our catalogue for over 30 years. An evergreen, with a name that speaks for itself; go to the beach, take time for yourselves, and restore your spirits at a place you love. A solid teak frame with textile or mesh sling available in a wide array of colours.





Tuskany

The Tuskany invites you to indulge in a luxurious outdoor escape, where comfort meets striking design. Its unique, tusk-shaped teak structure creates an elegant, sculptural presence, offering both beauty and stability. Sink into the plush, quick-drying cushions that cradle you in softness, while the adjustable backrests allow you to find the perfect lounging position with just a simple touch. For added serenity, optional flowing curtains can be drawn to create your own private sanctuary, making the Tuskany a tranquil oasis of comfort and style in any outdoor space.





Wave

The Wave, designed by Erik Nyberg & Gustav Ström, is a stunning fusion of avant-garde design and outdoor luxury. Its flowing, sculptural form creates a sense of weightlessness, as if it's floating effortlessly in any outdoor space. Crafted from durable stainless steel and Batyline fabric, the Wave offers both strength and comfort, making it a standout piece for relaxation.

The adjustable canopy provides shade and shelter, allowing you to find the perfect balance between sun and shade, while the gentle curve of the structure invites you to relax in style. The Wave is more than just a sunlounger—it's a bold statement of design, where elegance meets innovation.







Xqi



Alura



Alura Cushion



Beacher



Calypso



Calypso



Calypso



Ninix



QT



XQI



Styletto



Styletto



Styletto Cushion



O-Zon



O-Zon Cushion



Zenhit



Zenhit Cushion



Wave



Tuskany

Parasols





Palma

Inspired by the elegant movement of palm leaves, Kris Van Puyvelde designed the Palma parasol to seamlessly blend beauty with pioneering innovation. Winner of the prestigious Best-of-Best Red Dot Design Award, the Palma is the world's first pneumatic parasol, allowing it to open and close effortlessly with a simple hand gesture. Every detail has been meticulously thought through—there are no visible screws or mechanisms, creating a clean, minimalist aesthetic. Its organic form, combined with a flexible rotating base, ensures the Palma can follow the sun's path, offering optimal comfort throughout the day. Crafted from durable, weather-resistant materials, the Palma is more than a parasol—it's a masterpiece of design and functionality, elevating any outdoor space with its effortless sophistication.









Shady

Royal Botania takes the traditional parasol to new heights with the Shady, setting a new standard for outdoor luxury. With its intricately designed framework, cast stainless steel fittings, and premium acrylic covers, the Shady transcends conventional designs to become the epitome of sophisticated outdoor living. The Slim version maintains the elegant aesthetics of the original while offering a sleeker profile, perfect for more compact spaces.





Oazz

A successor to the innovative Palma parasol, the Oazz, designed by Kris Van Puyvelde, continues to revolutionize outdoor parasol with its automatic opening system and refined aesthetics. Its straightforward framework and unique cover placement between the ribs offer a minimalist look at a more accessible price point.





Bloom

Reinvented for greater functionality and succeeding the acclaimed Palma, Bloom is equipped with a lever-operated spindle system enabling larger canopy sizes. This advanced mechanism aligns the parasols supporting ribs into a unified, organically shaped strutless structure, mirroring the elegance of a flower in bloom. Available in various sizes and configurations, with aluminium ribs and a stainless-steel pole offered in multiple finishes, the Bloom merges sculptural aesthetics with practical sophistication to enhance any outdoor environment.





Palma



Bloom Square



Bloom Round



Oazz Round



Oazz Square



Shady



Shady Round



Shady Slim Square



Shady Slim round



Lighting





Meduz

Infuse your terrace with an extra touch of luxury with our Meduz lamp. This decorative tripod lamp is a perfect statement piece, adding an artistic flair to any high-end terrace setting.









Dome

Embrace the elegance of the Roaring Twenties with the Dome collection. Featuring sleek coated aluminum and handmade glass, these ceiling lights bring a touch of vintage luxury to your outdoor spaces. Perfect for creating a glamorous ambiance, the Dome lights are a timeless addition to any setting.









Luniz

Elevate the ambiance of your outdoor space with our Luniz lamp. This opulent three-armed decorative lamp serves as the perfect companion to any lounge set. With the ability to customize the lampshades across three different sizes and our vast array of fabric colors, this piece provides unprecedented versatility. In addition, the base of the lamp can be decorated with our fine selection of ceramics, offering another layer of personalization.





Club Lounge

A large patio lamp with a four-leg design, the Club Lounge is crafted from premium teak and stainless steel. Available in two colors, offering versatile and stylish outdoor lighting solutions.

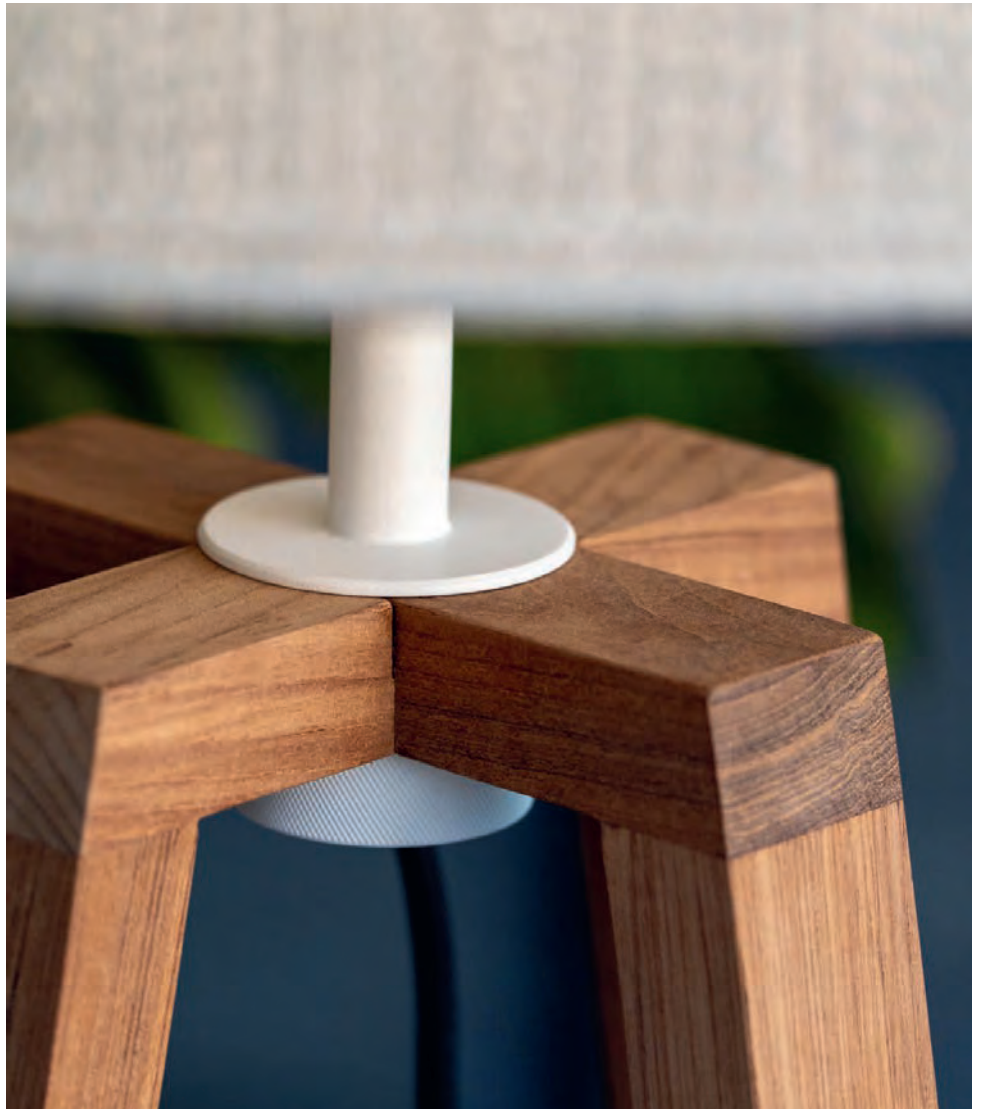



Ropy

Its powder coated aluminium frame is nicely wrapped with a decorative polyolefin rope. Colors are black, green, and sand. An efficient solar panel stores energy into a large battery during daytime, to grant you a long lasting glow after sunset. Also rechargeable via USB connection. Available both in a small table model as in a larger size with a handle to carry it anywhere.





Tristar

Our Tristar outdoor lamp features a frame made of either teak or coated stainless steel, with handmade glass. Available in two sizes, it offers a choice of clear or smoke glass.





Club Lounge



Meduz



Luniz



Dome



Dome



Ropy



Septem



Q-Bic



Fungy



Parker



Tristar



Tesla



Accessories





Cuprum

Cuprum's luxury planters are perfect for those who appreciate quality and craftsmanship. Made from the finest materials and designed with precision, these planters are both functional and beautiful. They are ideal for adding a touch of sophistication to any outdoor area, whether you're looking to create a stunning entrance to your home, or want to add some greenery to your terrace.

The brass used in Cuprum's planters is a particularly beautiful material, with a warm, golden hue that adds a touch of elegance to any space.

The Cuprum collection is also available in colour-fast and UV-resistant polyester for indoor and outdoor use.









Botaniq

The Botaniq planters' clean lines and robust construction evoke a sense of enduring craftsmanship, while their sleek design ensures they fit effortlessly into modern outdoor settings. Whether used to frame an entryway, line a terrace, or accentuate a garden, the Botaniq planter provides a sophisticated and lasting solution to elevate any outdoor space.





Bariq

Introducing Bariq, where organic design meets natural beauty. The Bariq planter features a gracefully rounded form, encased in full teak slats that are carefully crafted to follow the organic curves of the design. Crafted from premium teak, these planters bring warmth and sophistication while ensuring lasting durability against the elements.

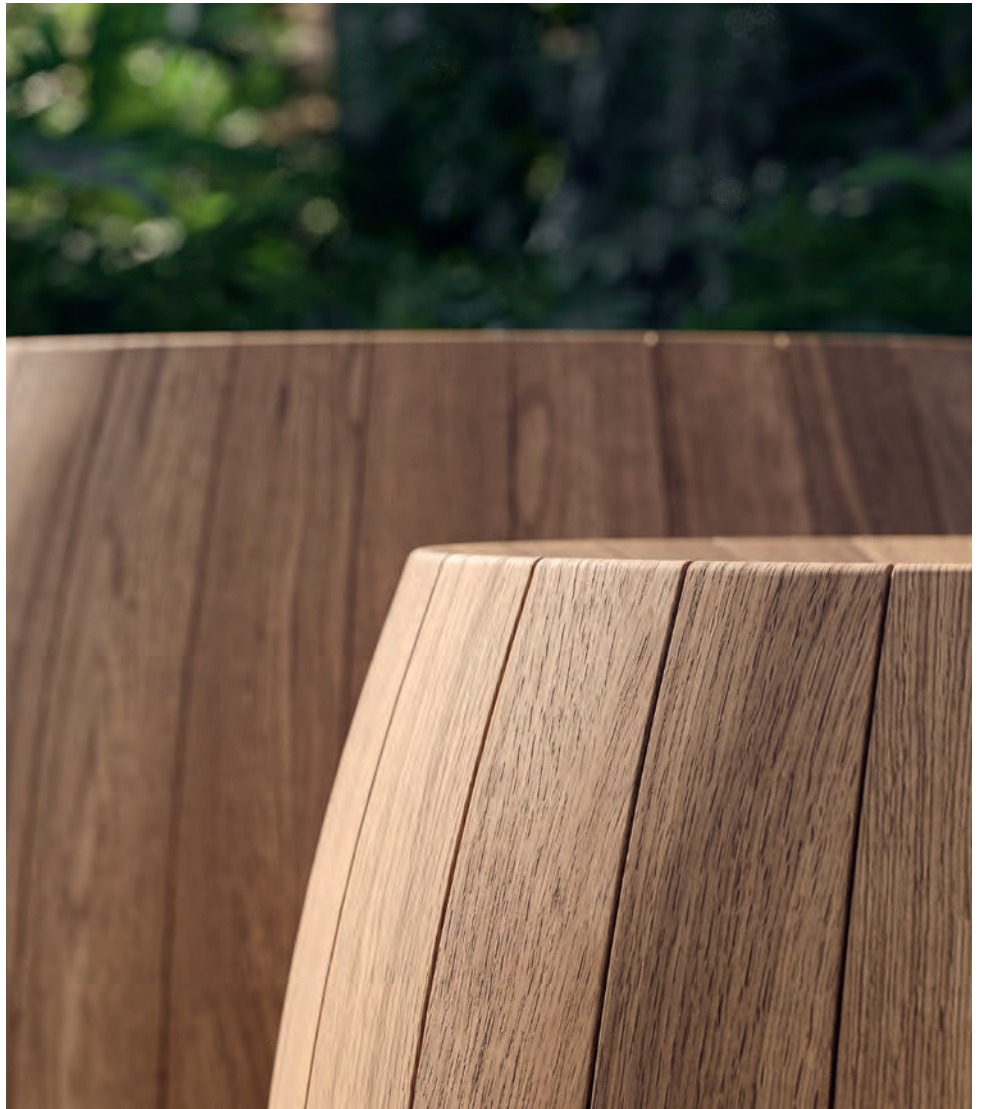



Outdoor Rugs

Soft, subdued colours, beautifully woven natural fibres - Royal Botania rugs are a balm for careworn feet and a joy to the eye. Simple design and organic materials infuse your exclusive garden with hygge and unite each unique element of your outdoor furniture in rich harmony.

Our collection comprises of square and round rugs in four different shades, Bark, Rock, Granite & Olive.









Tono Pouf

Tono redefines the concept of outdoor poufs with its innovative design featuring a rigid, water-resistant structure and removable upholstery secured by Velcro. This multifunctional piece offers extensive color and texture customization, quick drying capabilities, and additional storage space, making it an exceptionally practical choice for modern outdoor settings.









Bariq



Botaniq



Cuprum Round



Cuprum Square



Cuprum Round Plastic



Tono Small



Tono Large



Rug Round



Rug Square



ELMINA[®]
môj životný štýl

ELMINA Bratislava
OC LIGHTPARK, prízemie
Račianska 90, Bratislava
tel.: +421 910 919 711
e-mail: elmina@elmina.sk
www.elmina.sk
www.elmina.cz



ELMINA[®]
môj životný štýl

ELMINA Bratislava
OC LIGHTPARK, prízemie
Račianska 90, Bratislava
web: www.elmina.sk
mail: elmina@elmina.sk
tel.: +421 910 919 711

Meet Cuprum, Royal Botania's alluring luxury planter collection. Designed by expert craftsman Jan Buelens, each planter flawlessly blends texture and form to coalesce the organic plant world and the material. Sublime harmony. Illuminated by an internal spark of innovation, Buelens' creative energy results in a stunning collection.

4	BRASS ROUND PLANTER
8	BRASS CUBE PLANTER
12	POLYESTER ROUND PLANTER
14	SPECIFICATIONS





BRASS ROUND PLANTER

Our elegant Brass Round Planter is available up to a generous two meters in diameter. Featuring Cuprum's hallmark innovative design, this planter embodies the lightness of being. Lightweight, it appears to effortlessly float above the surface, infusing your terrace or indoor space with a sense of timeless enchantment. Indoors or outdoors, your plants thrive with a special stainless steel drainage system and deep insulating rim. Add a flourish of timeless elegance to any setting with Royal Botania's Brass Round Planter.





CUPRUM 90CM ROUND WEATHERED BRASS FINISH

BRASS CUBE PLANTER

Our Brass Cube Planter is expertly crafted to meet our exacting quality, design, and functionality standards. Available in four sizes — 70 cm, 90 cm, 110 cm, and 140 cm — this square-shaped planter seamlessly blends structure and fluidity. And with its sophisticated, Art Deco-reminiscent ambience, the cube planter's polish makes it the perfect outdoor or indoor conversation piece. Choose the Brass Cube Planter to elevate the aesthetic of any space, indoors or out.











POLYESTER ROUND PLANTER

Versatile. Welcoming. Warm. Royal Botania's Polyester Round Planter invites you to stylishly embrace the possibilities. Colour-fast and UV-resistant, choose from a rainbow palette of soft and bold RAL colours to imbue your indoor or outdoor space with a hue exclusive to you. Available in several sizes, this exclusive outdoor garden solution perfectly meets your project's unique needs. Featuring an extra wide rim, our planters offer superior insulation to help plants flourish. Make the Polyester Round Planter yours to joyously enhance your outdoor living space or interior your way.

BRASS ROUND PLANTER

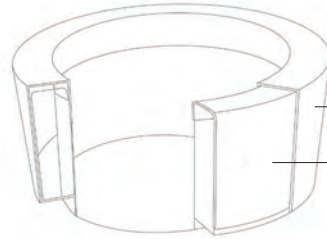

POLISHED GOLD BRASS



WEATHERED BRASS



BRASS CLADDING

POLYESTER CORE

BRASS ROUND WEATHERED	DIAMETER	INNER CIRCLE	HEIGHT	WEIGHT	VOLUME
CPR052RWB	52 CM	38 CM	28 CM	9,1 KG	25 L
CPR062RWB	62 CM	46 CM	32 CM	12,5 KG	50 L
CPR070RWB	70 CM	50 CM	36 CM	17 KG	70 L
CPR090RWB	90 CM	65 CM	49 CM	25 KG	160 L
CPR110RWB	110 CM	80 CM	56 CM	40 KG	280 L
CPR140RWB	140 CM	100 CM	66 CM	70 KG	500 L
CPR170RWB	170 CM	120 CM	76 CM	96 KG	850 L
CPR200RWB	200 CM	140 CM	86 CM	130 KG	1300 L

BRASS ROUND GOLD	DIAMETER	INNER CIRCLE	HEIGHT	WEIGHT	VOLUME
CPR052RGB	52 CM	38 CM	28 CM	9,1 KG	25 L
CPR062RGB	62 CM	46 CM	32 CM	12,5 KG	50 L
CPR070RGB	70 CM	50 CM	36 CM	17 KG	70 L
CPR090RGB	90 CM	65 CM	49 CM	25 KG	160 L
CPR110RGB	110 CM	80 CM	56 CM	40 KG	280 L
CPR140RGB	140 CM	100 CM	66 CM	70 KG	500 L
CPR170RGB	170 CM	120 CM	76 CM	96 KG	850 L
CPR200RGB	200 CM	140 CM	86 CM	130 KG	1300 L

BRASS CUBE PLANTER

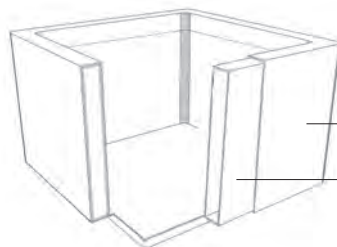

POLISHED GOLD BRASS



WEATHERED BRASS



BRASS CLADDING

POLYESTER CORE

BRASS CUBE WEATHERED	WIDTH	DEPTH	HEIGHT	WEIGHT	VOLUME
CPR0707WB	70 X 70 CM	58 X 58 CM	52 CM	30 KG	160 L
CPR0909WB	90 X 90 CM	76 X 76 CM	62 CM	50 KG	350 L
CPR1111WB	110 X 110 CM	92 X 92 CM	72 CM	70 KG	580 L
CPR1414WB	140 X 140 CM	118 X 118 CM	84 CM	105 KG	900 L

BRASS CUBE GOLD	WIDTH	DEPTH	HEIGHT	WEIGHT	VOLUME
CPR0707GB	70 X 70 CM	58 X 58 CM	52 CM	30 KG	160 L
CPR0909GB	90 X 90 CM	76 X 76 CM	62 CM	50 KG	350 L
CPR1111GB	110 X 110 CM	92 X 92 CM	72 CM	70 KG	580 L
CPR1414GB	140 X 140 CM	118 X 118 CM	84 CM	105 KG	900 L

"STANDARD"

Of these products we keep an inventory based on expected sales quantities.

"ON REQUEST"

Limited or no inventory. Delivery time of these products is on demand.

Consult us for lead time, or check our online stocklist.

POLYESTER ROUND PLANTER

POLYESTER - AVAILABLE IN ANY RAL COLOUR

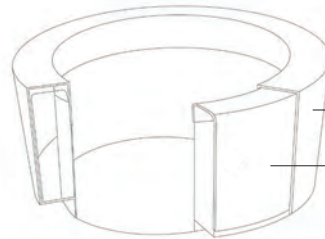

COLOURED GEL COAT

POLYESTER CORE

POLYESTER ROUND RAL	DIAMETER	INNER CIRCLE	HEIGHT	WEIGHT	VOLUME
CPR070RPRAL...	70 CM	50 CM	36 CM	13 KG	70 L
CPR090RPRAL...	90 CM	65 CM	49 CM	14 KG	160 L
CPR110RPRAL...	110 CM	80 CM	56 CM	26 KG	280 L
CPR140RPRAL...	140 CM	100 CM	66 CM	47 KG	500 L

FORKLIFT

Cuprum round and square planters, size 140 cm and up, can easily be handled by a forklift.

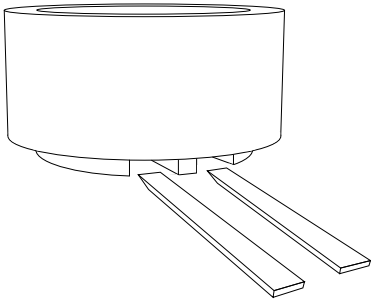

STAINLESS STEEL DRAINAGE

For indoor use, the drainage system must be closed



For outdoor use, the drainage system must be left open.



ELMINA[®]
môj životný štýl

ELMINA Bratislava
OC LIGHTPARK, prízemie
Račianska 90, Bratislava
tel.: +421 910 919 711
e-mail: elmina@elmina.sk
www.elmina.sk
www.elmina.cz